

4 x  $\varnothing 20$

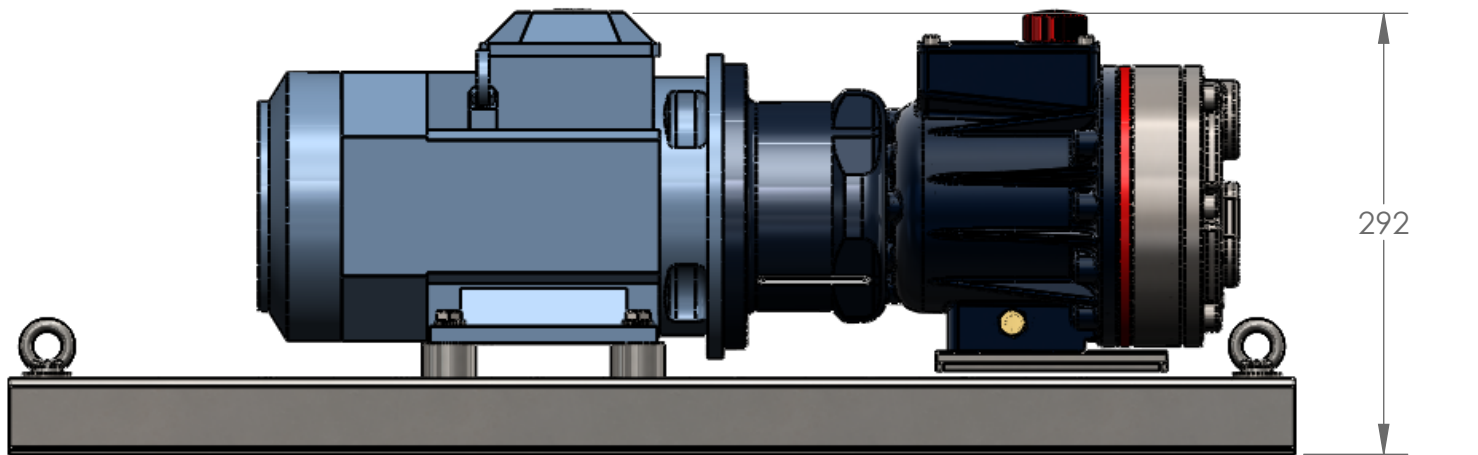

G10 - IEC 90 - MA

66 Kg